

# Miniature Cylindrical Proximity Sensor

# E2E

## High performance in small sizes

- pre-wired and M8 connector models
- 4 mm, 5.4 mm and M5 sizes
- response frequency up to 3 kHz



## Ordering Information

Size		Sensing Distance	Connection	Housing Material	Output	Operation mode NO	Operation mode NC
dia 4 mm	shielded	0.8mm	pre-wired	brass	PNP	E2E-CR8C1	E2E-CR8C2
			M8 connector		NPN	E2E-CR8C1	E2E-CR8C2
					PNP	E2E-CR8C1-M5	E2E-CR8C2-M5
			M5		1mm	pre-wired	NPN
M8 connector	PNP	E2E-X1B1				E2E-X1B2	
	dia 5.4 mm		pre-wired		NPN	E2E-X1C1	E2E-X1C2
PNP					E2E-X1B1-M5	E2E-X1B2-M5	
			NPN		E2E-X1C1-M5	E2E-X1C2-M5	
				PNP	E2E-C1B1	E2E-C1B2	
				NPN	E2E-C1C1	E2E-C1C2	

### E2E-C□C□/B□, E2E-X1C□/B□ DC 3-wire Models

Item	Size	4 dia.	M5	5.4 dia.
	Type	Shielded		
		E2E-CR8C□/B□	E2E-X1C□/B□	E2E-C1C□/B□
Sensing distance		0.8 mm ±15%	1 mm ±15%	
Set distance		0 to 0.5 mm	0 to 0.7 mm	
Differential travel		15% max. of sensing distance		
Sensing object		Ferrous metal (The sensing distance decreases with non-ferrous metal, refer to <i>Engineering Data</i> .)		
Standard sensing object		Iron: 5 x 5 x 1 mm		
Response speed (See note.)		3 kHz		
Power supply voltage (operating voltage range)		12 to 24 VDC (10 to 30 VDC), ripple (p-p): 10% max.		
Current consumption		17 mA max.		
Control output	Load current	Open-collector output 100 mA max. (at 30 VDC max.)		
	Residual voltage	2 V max. (Load current: 100 mA , Cable length: 2 m)		
Indicator		Operation indicator (red LED)		
Operation mode (with sensing object approaching)		C1/-B1 Models:NO C2/-B2 Models:NC For details, refer to <i>Timing Charts</i> .		
Protection circuits		Power supply reverse polarity protection, surge suppressor		
Ambient temperature		Operating/Storage: -25°C to 70°C (with no icing or condensation)		
Ambient humidity		Operating/Storage: 35% to 95%		
Temperature influence		±15% max. of sensing distance at 23°C in the temperature range of -25°C to 70°C		
Voltage influence		±2.5% max. of sensing distance in the rated voltage range ±15%		
Insulation resistance		50 MΩ min. (at 500 VDC) between current-carrying parts and case		
Dielectric strength		500 VAC at 50/60 Hz for 1 min between current-carrying parts and case		
Vibration resistance		10 to 55 Hz, 1.5-mm double amplitude for 2 hours each in X, Y, and Z directions		

Size		4 dia.	M5	5.4 dia.
Type		Shielded		
Item		E2E-CR8□/B□	E2E-X1C□/B□	E2E-C1C□/B□
<b>Shock resistance</b>		500 m/s <sup>2</sup> 10 times each in X, Y, and Z directions		
<b>Degree of protection</b>		IEC 60529 IP67 (Pre-wired models: JEM standard IP67g (waterproof, oil-proof))		
<b>Connection method</b>		Pre-wired models (standard length 2 m), connector models		
<b>Weight (packed state)</b>	<b>Pre-wired models</b>	Approx. 60 g		
	<b>Connector models</b>	Approx. 12 g	Approx. 15 g	---
<b>Material</b>	<b>Case</b>	Stainless steel (SUS303)	Brass-nickel plated	
	<b>Sensing surface</b>	Heat-resistant ABS		
	<b>Clamping nuts</b>	Brass-nickel plated		
	<b>Toothed washer</b>	Iron-zinc plated		
<b>Accessories</b>		Instruction manual		

**Note:** The response speed is an average value. Measurement conditions are as follows: standard sensing object, a distance of twice the standard sensing object, and a set distance of half the sensing distance.

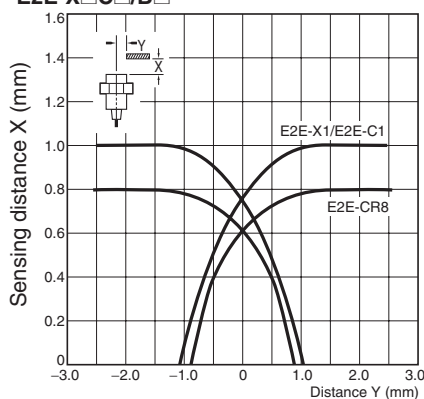
## Engineering Data

### E2E

#### Operating Range (Typical)

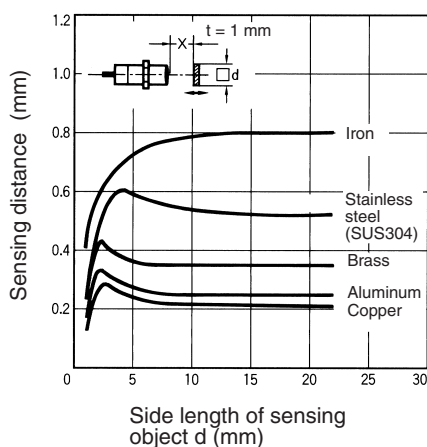
#### Shielded Models

E2E-C□C□/B□  
E2E-X□C□/B□

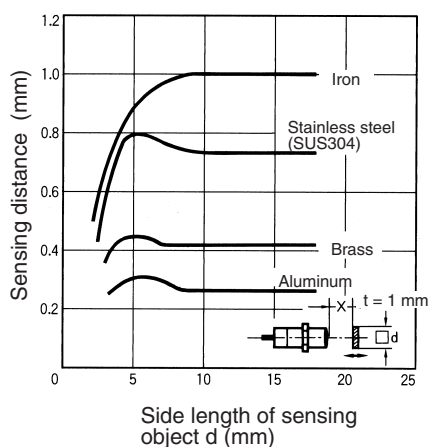


#### Sensing Distance vs. Sensing Object (Typical)

E2E-CR8□□



E2E-X1□□  
E2E-C1□□



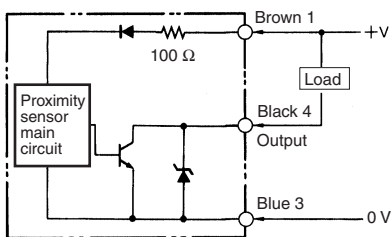
## Output Circuits and Timing Charts

### Output Circuits

#### DC 3-wire Models

##### E2E-C/X□C□

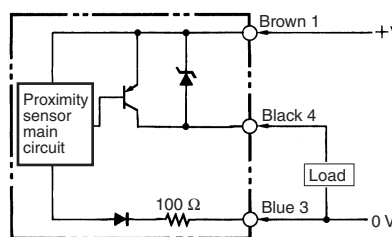
##### NPN Open-collector Output



\* Pin 4 is an NO contact, and pin 2 is an NC contact.

##### E2E-C/X□B□

##### PNP Open-collector Output

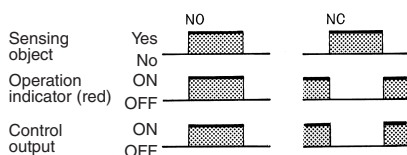


\* Pin 4 is an NO contact, and pin 2 is an NC contact.

### Timing Charts

##### E2E-C/X□C□/B□

##### NPN/PNP Open-collector Output



### Pin Arrangement

#### E2E-CR8C□/CR8B□/X1C□/X1B□-M5 DC 3-wire Models

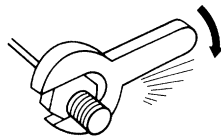
Connector	Operation mode	Applicable models	Pin arrangement
M8-3pin	NO/NC	E2E-CR8C□-M5 E2E-X1C□-M5	
	NO/NC	E2E-CR8B□-M5 E2E-X1B□-M5	



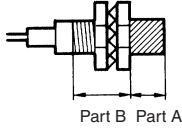
## Precautions

### Mounting

Do not tighten the nut with excessive force. A washer must be used with the nut.

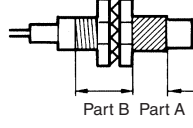


Shielded Model



Part B Part A

Unshielded Model

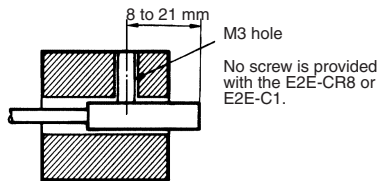


Part B Part A

**Note:** The table below shows the tightening torques for part A and part B nuts. In the previous examples, the nut is on the sensor head side (part B) and hence the tightening torque for part B applies. If this nut is in part A, the tightening torque for part A applies instead.

Model	Part A		Part B
	Length	Torque	Torque
M5	1 N·m		

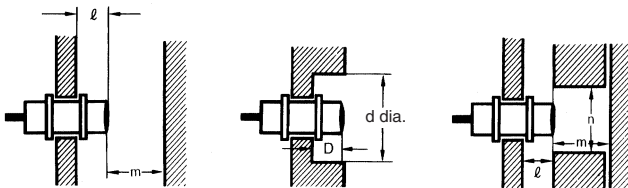
Refer to the following to mount the E2E-CR8 and E2E-C1 non-screw models.



Tighten the screw to a torque of 0.2 N·m maximum to secure the E2E-CR8 and a torque of 0.4 N·m maximum to secure the E2E-C1.

### Effects of Surrounding Metal

When mounting the E2E within a metal panel, ensure that the clearances given in the following table are maintained. Failure to maintain these distances may cause deterioration in the performance of the sensor.



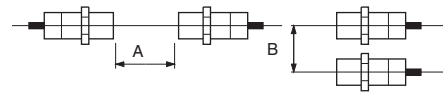
Model	Item	4 dia.	M5	5.4 dia.
E2E-X□C□ E2E-X□B□ E2E-C□C□ E2E-C□B□ DC 3-wire	Shielded			
	l	0 mm	0 mm	0 mm
	d	4 mm	5 mm	5.4 mm
	D	0 mm	0 mm	0 mm
	m	2.4 mm	3 mm	3 mm
	n	6 mm	8 mm	8 mm

### Relationship between Sizes and Models

Model	Model No.
4 dia.	Shielded E2E-CR8C□ E2E-CR8B□
M5	E2E-X1C□ E2E-X1B□
5.4 dia.	E2E-C1C□ E2E-C1B□

### Mutual Interference

When installing two or more Sensors face to face or side by side, ensure that the minimum distances given in the following table are maintained.



Model	Item	4 dia.	M5	5.4 dia.
E2E-X□B□ E2E-X□C□ E2E-C□B□ E2E-C□C□ DC 3-wire	Shielded			
	A	20 mm		
	B	15 mm		

**Note:** Values in parentheses apply to Sensors operating at different frequencies.

**! WARNING**

This product is not designed or rated for ensuring safety of persons. Do not use it for such purposes.



**Precautions for Safe Use**

The colors in parentheses are previous wire colors.

Item	Examples
<p><b>Power supply</b></p> <p>Do not impose an excessive voltage on the E2E, otherwise it may explode or burn. Do not impose 100 VAC on any E2E DC Model, otherwise it may explode or burn.</p>	<p>DC 3-wire Models</p> <p><b>Incorrect</b></p>
<p><b>Load short-circuit</b></p> <p>Do not short-circuit the load, or the E2E may explode or burn.</p> <p>The E2E's short-circuit protection function is valid if the polarity of the supply voltage imposed is correct and within the rated voltage range.</p>	<p>DC 3-wire Models (NPN output)</p> <p><b>Incorrect</b></p>
<p><b>Wiring</b></p> <p>Be sure to wire the E2E and load correctly, otherwise it may explode or burn.</p>	<p>DC 3-wire Models (NPN output)</p> <p><b>Incorrect</b>      <b>Incorrect</b></p>
<p><b>Connection with no load</b></p> <p>Make sure to connect a proper load to the E2E in operation, otherwise it may explode or burn.</p>	<p>DC 3-wire Models</p> <p><b>Incorrect</b></p>

E2E

**Precautions for Correct Use**

**Installation**

**Power Reset Time**

The Proximity Sensor is ready to operate within 100 ms after power is supplied. If power supplies are connected to the Proximity Sensor and load respectively, be sure to supply power to the Proximity Sensor before supplying power to the load.

**Power OFF**

The Proximity Sensor may output a pulse signal when it is turned OFF. Therefore, it is recommended to turn OFF the load before turning OFF the Proximity Sensor.

**Power Supply Transformer**

When using a DC power supply, make sure that the DC power supply has an insulated transformer. Do not use a DC power supply with an auto-transformer.

**Sensing Object**

**Metal Coating:**

The sensing distances of the Proximity Sensor vary with the metal coating on sensing objects.

**Wiring**

**High-tension Lines**

**Wiring through Metal Conduit**

If there is a power or high-tension line near the cable of the Proximity Sensor, wire the cable through an independent metal conduit to prevent against Proximity Sensor damage or malfunctioning.

**Cable Tractive Force**

Do not pull on cables with tractive forces exceeding the following.

Diameter	Tractive force
4 dia. max.	30 N max.
4 dia. min.	50 N max.

**Mounting**

The Proximity Sensor must not be subjected to excessive shock with a hammer when it is installed, otherwise the Proximity Sensor may be damaged or lose its water-resistivity.

**Environment**

**Water Resistivity**

Do not use the Proximity Sensor underwater, outdoors, or in the rain.



**Operating Environment**

Be sure to use the Proximity Sensor within its operating ambient temperature range and do not use the Proximity Sensor outdoors so that its reliability and life expectancy can be maintained. Although the Proximity Sensor is water resistive, a cover to protect the Proximity

Sensor from water or water soluble machining oil is recommended so that its reliability and life expectancy can be maintained. Do not use the Proximity Sensor in an environment with chemical gas (e.g., strong alkaline or acid gasses including nitric, chromic, and concentrated sulfuric acid gases).

**Connection to a PLC**

**Required Conditions**

Connection to a PLC is possible if the specifications of the PLC and the Proximity Sensor satisfy the following conditions. (The meanings of the symbols are given below.)

1. The ON voltage of the PLC and the residual voltage of the Proximity Sensor must satisfy the following.  
 $V_{ON} \leq V_{CC} - V_R$
2. The OFF current of the PLC and the leakage current of the Proximity Sensor must satisfy the following.  
 $I_{OFF} \geq I_{leak}$   
 (If the OFF current is not listed in the specifications, take it to be **1.3 mA**.)
3. The ON current of the PLC and the control output ( $I_{OUT}$ ) of the Proximity Sensor must satisfy the following.  
 $I_{OUT(min)} \leq I_{ON} \leq I_{OUT(max)}$   
 The ON current of the PLC will vary, however, with the power supply voltage and the input impedance used as shown in the following equation.  
 $I_{ON} = (V_{CC} - V_R - \frac{V_{PC}}{R_{IN}})$

**Example**

In this example, the above conditions are checked for when the PLC model is the C200H-ID212, the Proximity Sensor model is the E2E-X7D1-N, and the power supply voltage is 24 V.

1.  $V_{ON} (14.4 V) \leq V_{CC} (20.4 V) - V_R (3 V) = 17.4 V$ : OK
2.  $I_{OFF} (1.3 mA) \geq I_{leak} (0.8 mA)$ : OK
3.  $I_{ON} = [V_{CC} (20.4 V) - V_R (3 V) - \frac{V_{PC} (4 V)}{R_{IN} (3 k\Omega)}] \approx 4.5 mA$   
 Therefore,  
 $I_{OUT(min)} (3 mA) \leq I_{ON} (4.5 mA)$ : OK

$V_{ON}$ : ON voltage of PLC (14.4 V)  
 $I_{ON}$ : ON current of PLC (typ. 7 mA)  
 $I_{OFF}$ : OFF current of PLC (1.3 mA)  
 $R_{IN}$ : Input impedance of PLC (3 kΩ)  
 $V_{PC}$ : Internal residual voltage of PLC (4 V)  
 $V_R$ : Output residual voltage of Proximity Sensor (3 V)  
 $I_{leak}$ : Leakage current of Proximity Sensor (0.8 mA)  
 $I_{OUT}$ : Control output of Proximity Sensor (3 to 100 mA)  
 $V_{CC}$ : Power supply voltage (PLC: 20.4 to 26.4 V)  
 Values in parentheses are for the following PLC model and Proximity Sensor model.  
 PLC: C200H-ID212  
 Proximity Sensor: E2E-X7D1-N  
 Note: please refer to complete E2E/E2E2 datasheet for details on E2E-X7D1-N

Model	Connection type	Method	Description
DC 3-wire	AND (serial connection)	<p style="text-align: center;"><b>Correct</b></p>	<p>The Sensors connected together must satisfy the following conditions.</p> <p><math>i_L + (N - 1) \times i \leq</math>Upper-limit of control output of each Sensor</p> <p><math>V_S - N \times V_R \geq</math> Load operating voltage</p> <p>N: No. of Sensors</p> <p><math>V_R</math>: Residual voltage of each Sensor</p> <p><math>V_S</math>: Supply voltage</p> <p>i: Current consumption of the Sensor</p> <p><math>i_L</math>: Load current</p> <p>If the MY Relay, which operates at 24 VDC, is used as a load for example, a maximum of two Proximity Sensors can be connected to the load.</p>



## Dimensions

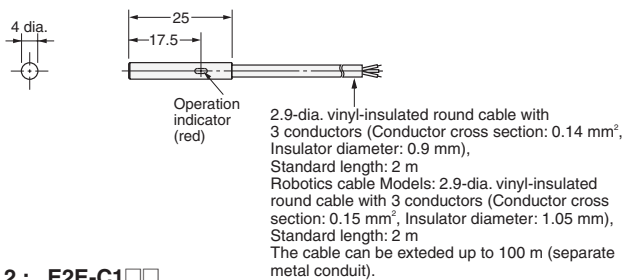
**Note:** All units are in millimeters unless otherwise indicated.

### E2E

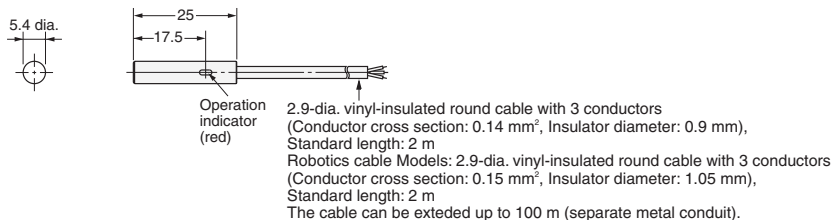
Model			DC 3-wire	
			Model No.	Figure No.
Pre-wired	Shielded	4 dia.	E2E-CR8□□	1
		M5	E2E-X1□□	3
		5.4 dia.	E2E-C1□□	2
Connector (M8-3 pin)	Shielded	4 dia.	E2E-CR8□□-M5	35
		M5	E2E-X1□□-M5	36

### Pre-wired Models (Shielded)

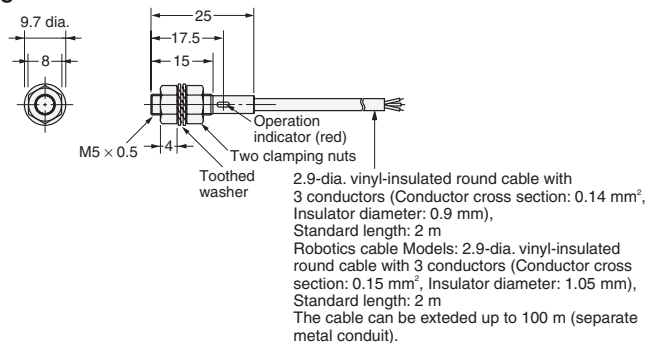
**Fig. 1 : E2E-CR8□□**



**Fig. 2 : E2E-C1□□**

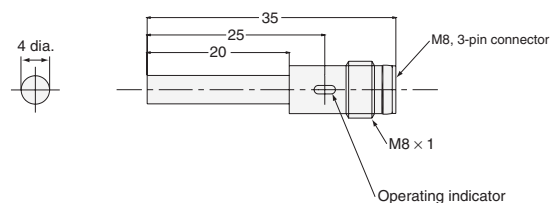


**Fig. 3 : E2E-X1□□**

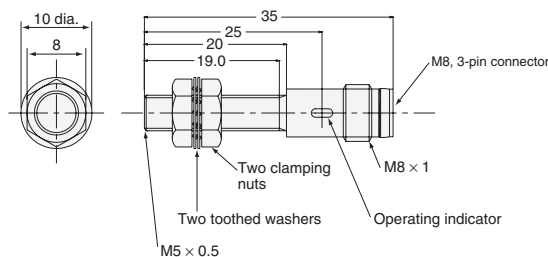


### M8 (3 pin) Connector Models (Shielded)

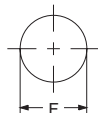
**Fig. 35 : E2E-CR8□□-M5**



**Fig. 36 : E2E-X1□□-M5**



### Mounting Holes



Dimensions	M4	M5	5.4 dia.
F (mm)	4.2 <sup>+0.5</sup> dia.	5.5 <sup>+0.5</sup> dia.	5.7 <sup>+0.5</sup> dia.

## Warranties and Limitations of Liability

### WARRANTY

OMRON's exclusive warranty is that the products are free from defects in materials and workmanship for a period of one year (or other period if specified) from date of sale by OMRON.

OMRON MAKES NO WARRANTY OR REPRESENTATION, EXPRESS OR IMPLIED, REGARDING NON-INFRINGEMENT, MERCHANTABILITY, OR FITNESS FOR PARTICULAR PURPOSE OF THE PRODUCTS. ANY BUYER OR USER ACKNOWLEDGES THAT THE BUYER OR USER ALONE HAS DETERMINED THAT THE PRODUCTS WILL SUITABLY MEET THE REQUIREMENTS OF THEIR INTENDED USE. OMRON DISCLAIMS ALL OTHER WARRANTIES, EXPRESS OR IMPLIED.

### LIMITATIONS OF LIABILITY

OMRON SHALL NOT BE RESPONSIBLE FOR SPECIAL, INDIRECT, OR CONSEQUENTIAL DAMAGES, LOSS OF PROFITS OR COMMERCIAL LOSS IN ANY WAY CONNECTED WITH THE PRODUCTS, WHETHER SUCH CLAIM IS BASED ON CONTRACT, WARRANTY, NEGLIGENCE, OR STRICT LIABILITY.

In no event shall responsibility of OMRON for any act exceed the individual price of the product on which liability is asserted.

IN NO EVENT SHALL OMRON BE RESPONSIBLE FOR WARRANTY, REPAIR, OR OTHER CLAIMS REGARDING THE PRODUCTS UNLESS OMRON'S ANALYSIS CONFIRMS THAT THE PRODUCTS WERE PROPERLY HANDLED, STORED, INSTALLED, AND MAINTAINED AND NOT SUBJECT TO CONTAMINATION, ABUSE, MISUSE, OR INAPPROPRIATE MODIFICATION OR REPAIR.

## Application Considerations

### SUITABILITY FOR USE

THE PRODUCTS CONTAINED IN THIS CATALOG ARE NOT SAFETY RATED. THEY ARE NOT DESIGNED OR RATED FOR ENSURING SAFETY OF PERSONS, AND SHOULD NOT BE RELIED UPON AS A SAFETY COMPONENT OR PROTECTIVE DEVICE FOR SUCH PURPOSES. Please refer to separate catalogs for OMRON's safety rated products.

OMRON shall not be responsible for conformity with any standards, codes, or regulations that apply to the combination of products in the customer's application or use of the product.

Take all necessary steps to determine the suitability of the product for the systems, machines, and equipment with which it will be used.

Know and observe all prohibitions of use applicable to this product.

NEVER USE THE PRODUCT FOR AN APPLICATION INVOLVING SERIOUS RISK TO LIFE OR PROPERTY WITHOUT ENSURING THAT THE SYSTEM AS A WHOLE HAS BEEN DESIGNED TO ADDRESS THE RISKS, AND THAT THE OMRON PRODUCT IS PROPERLY RATED AND INSTALLED FOR THE INTENDED USE WITHIN THE OVERALL EQUIPMENT OR SYSTEM.

## Disclaimers

### CHANGE IN SPECIFICATIONS

Product specifications and accessories may be changed at any time based on improvements and other reasons. Consult with your OMRON representative at any time to confirm actual specifications of purchased product.

### DIMENSIONS AND WEIGHTS

Dimensions and weights are nominal and are not to be used for manufacturing purposes, even when tolerances are shown.

ALL DIMENSIONS SHOWN ARE IN MILLIMETERS.

To convert millimeters into inches, multiply by 0.03937. To convert grams into ounces, multiply by 0.03527.