

# Cylindrical Proximity Sensor in Plastic Housing

## E2F

- High quality full body plastic housing for high water proof requirements
- Polyarylate housing for light chemical resistance



### Applications

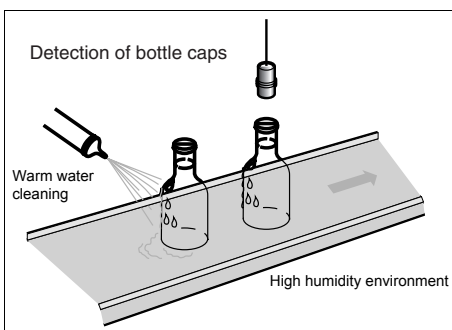

### Ordering Information

#### Sensors

Model	Sensing distance	Output specifications	Model	
			Operating status	
			NO	NC
Shielded 	M8 1.5mm	DC 3-wire NPN	E2F-X1R5E1	E2F-X1R5E2
		AC 2-wire Models	E2F-X1R5Y1	E2F-X1R5Y2
	M12 2mm	DC 3-wire NPN	E2F-X2E1 *1	E2F-X2E2 *1
		AC 2-wire Models	E2F-X2Y1 *1	E2F-X2Y2 *1
	M18 5mm	DC 3-wire NPN	E2F-X5E1 *1	E2F-X5E2 *1
		AC 2-wire Models	E2F-X5Y1 *1 *2	E2F-X5Y2 *1 *2
	M30 10mm	DC 3-wire NPN	E2F-X10E1 *1	E2F-X10E2 *1
		AC 2-wire Models	E2F-X10Y1 *1 *2	E2F-X10Y2 *1 *2

\*1. A different frequency type is available. (E2F-X□□5; e.g. E2F-X5E15)

\*2. A short-circuit protection type is available. (E2F-X□Y□-53; e.g. E2F-X5Y1-53) Power supply voltage: 100 to 120 VAC

#### Accessories (Order Separately)



Rating/performance

Model		E2F-X1R5E□ E2F-X1R5Y□	E2F-X2E□ E2F-X2Y□	E2F-X5E□ E2F-X5Y□	E2F-X10E□ E2F-X10Y□
Item					
Sensing distance		1.5 mm ±10%	2 mm ±10%	5 mm ±10%	10 mm ±10%
Setting distance		0 to 1.2 mm	0 to 1.6 mm	0 to 4 mm	0 to 8 mm
Differential distance		10% max.			
Sensing object		Ferrous metal (Sensitivity lowers with non-ferrous metals)			
Standard sensing object		Iron, 8 × 8 × 1 mm	Iron, 12 × 12 × 1 mm	Iron, 18 × 18 × 1 mm	Iron, 30 × 30 × 1 mm
Response frequency*1		E models: 2 kHz, Y models: 25 Hz	E models: 1.5 kHz, Y models: 25 Hz	E models: 600 Hz, Y models: 25 Hz	E models: 400 Hz, Y models: 25 Hz
Power supply(Operating voltage range)		E models: 12 to 24 VDC (10 to 30 VDC), ripple (p-p): 10% max. Y models: 24 to 240 VAC (20 to 264 VAC)			
Current consumption		E models: 17 mA max.			
Leakage current		Y models: 1.7 mA at 200 VAC			
Control output	Switching capacity	E models: 200 mA max. Y models: 5 to 100 mA		E models: 200 mA max. Y models: 5 to 300 mA	
	Residual voltage	E models: 2 V max. (load current: 200 mA with cable length: 2 m) Y models: Refer to the Specifications			
Indicator lamp		E models: Detection indicator (red LED) Y models: Operation indicator (red LED)			
Operating status (with sensing object approaching)		E1, Y1 models: ON E2, Y2 models: NC			
Protective circuits		E models: Reverse connection protection, load short-circuit protection, surge absorber Y models: None			
Ambient temperature		Operating/Storage: -25° C to 70° C (with no icing or condensation)			
Ambient humidity		Operating/Storage: 35% to 95%RH			
Temperature influence		A maximum fluctuation of ±10% max. of sensing distance at 23° C in temperature range of -25° C and 70° C			
Voltage influence		E models: ±2.5% max. of sensing distance within a range of ±15% of rated power supply voltage Y models: ±1% max. of sensing distance within a range of ±10% of rated power supply voltage			
Insulation resistance		50 MΩ min. (at 500 VDC) between current carry parts and case			
Dielectric strength		E models: 1,000 VAC, 50/60 Hz for 1 min between current carry parts and case			
Vibration resistance		10 to 55 Hz, 1.5-mm double amplitude for 2 hours each in X, Y, and Z directions			
Shock resistance		Destruction: 1,000 m/s <sup>2</sup> for 10 times each in X, Y, and Z directions			
Protective structure		IEC IP67			
Connection method		Pre-wired models (standard length: 2 m)			
Weight (Packed state)		Approx.40g	Approx. 50 g	Approx. 130 g	Approx. 170 g
Material	Case	Polyarylate			
	Sensing surface				
	Clamping nut	Polyallylate resin			
Accessories		Instruction manual			

\*1. The response frequencies are average values measured on condition that the distance between each sensing object is twice as large as the size of the sensing object and the sensing distance set is half of the maximum sensing distance.

## Characteristic data (typical)

### Sensing Distance vs. Sensing Object

**E2F-X1R5**□□

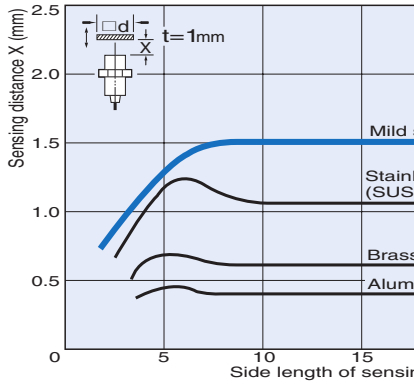

**E2F-X2**□□

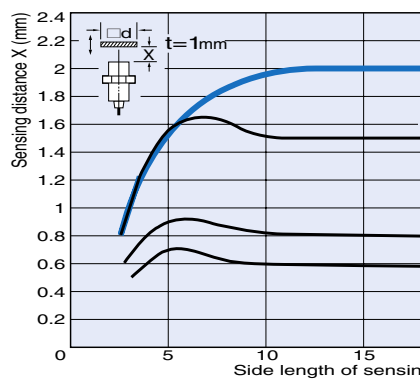

**E2F-X5**□□

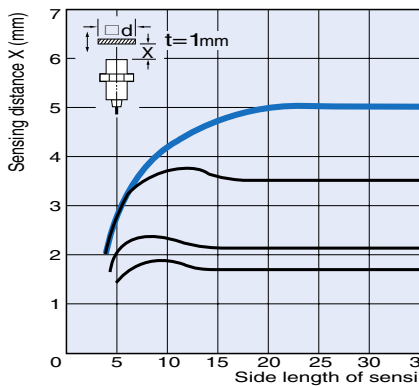

**E2F-X10**□□

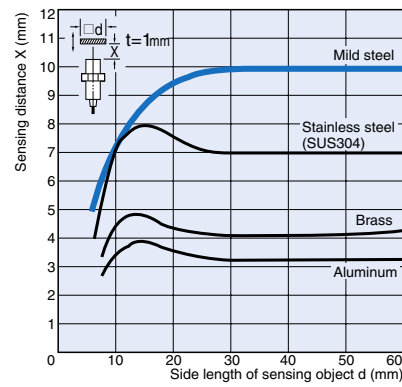

## Output Circuit Diagram

Output	Operating status	Model	Timing chart	Output circuit
DC 3-wire	NO	E2F-X1R5E1 E2F-X2E1 E2F-X5E1 E2F-X10E1		<p>*1. 200 mA max. (source current) *2. When connecting to the transistor circuit.</p>
	NC	E2F-X1R5E2 E2F-X2E2 E2F-X5E2 E2F-X10E2		
AC 2-wire Models	NO	E2F-X1R5Y1 E2F-X2Y1 E2F-X5Y1 E2F-X10Y1		
	NC	E2F-X1R5Y2 E2F-X2Y2 E2F-X5Y2 E2F-X10Y2		

Precautions

Correct Use

Design

Effects of Surrounding Metal

Provide a minimum distance as shown in the table below between the Sensor and the surrounding metal.

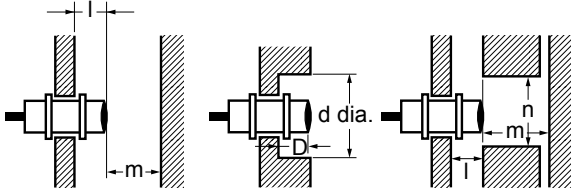

Effects of Surrounding Metal(Unit: mm)

Model	Item	l	d	D	m	n
E2F-X1R5□□	0	0	8	0	4.5	12
E2F-X2□□			12		8	18
E2F-X5□□			18		20	27
E2F-X10□□			30		40	45

Mutual Interference

When installing two or more Sensors face-to-face or side-by-side, ensure that the minimum distances given in the following table are maintained.

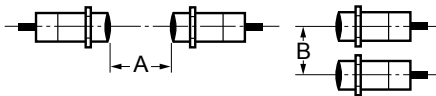

Mutual Interference (Unit: mm)

Model	Item	A	B
E2F-X1R5□□		20	15
E2F-X2□□		30 (20)	20(12)
E2F-X5□□		50 (30)	35 (18)
E2F-X10□□		100(50)	70(35)

Note: Figures in parentheses are for an E2F used in combination with an E2F (i.e., E2F-X□□□5) that is operating at a different frequency.

Mounting

Do not apply excessive torque when tightening any nuts.

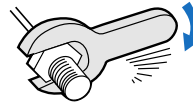

Model	Tensile strength (torque)
E2F-X1R5□□	0.78 N•m
E2F-X2□□	
E2F-X5□□	2 N•m
E2F-X10□□	

● Maintenance and Inspection

Do not use the AC 2-wire models (sensing surface is broken), where directly exposed to water. There is fear of an electric shock.

Dimensions (Unit: mm)

DC 3-wire Models

E2F-X1R5E

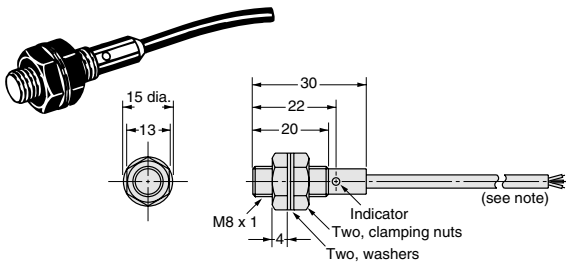

Note:  
Vinyl-insulated round cord, 3.5 dia.,  
3 cores (0.12 dia. x 13); Standard length: 2m

E2F-X2E

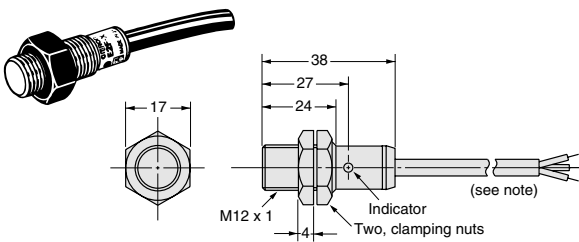

Note:  
Oil-and vibration-resistant,  
vinyl-insulated round cord, 6 dia.,  
0.5 dia. x 3 cores; Standard length: 2m  
The cord can be extended up to 200 m  
in an independent metal conduit.

E2F-X5E

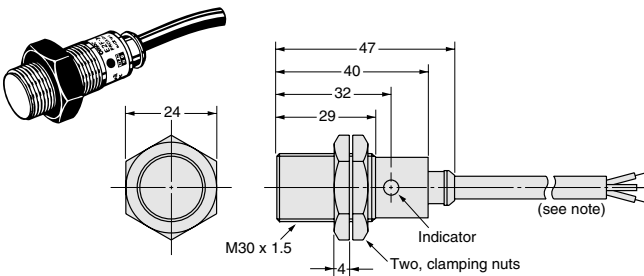

Note:  
Oil-and vibration-resistant,  
vinyl-insulated round cord, 6 dia.,  
0.5 dia. x 2 cores; Standard length: 2m  
The cord can be extended up to 200 m  
in an independent metal conduit.

AC 2-wire Models

E2F-X1R5Y

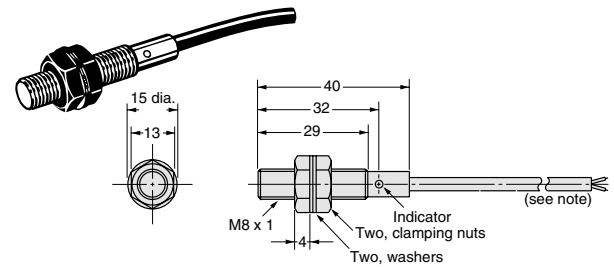

Note:  
Vinyl-insulated round cord, 3.5 dia.,  
3 cores (0.12 dia. x 13); Standard length: 2m

E2F-X2Y

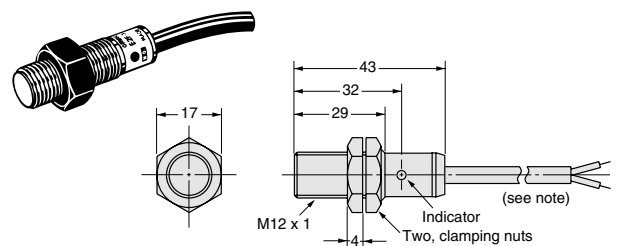

Note:  
Oil-and vibration-resistant,  
vinyl-insulated round cord, 6 dia.,  
0.5 dia. x 2 cores; Standard length: 2m  
The cord can be extended up to 200 m  
in an independent metal conduit.

E2F-X5Y

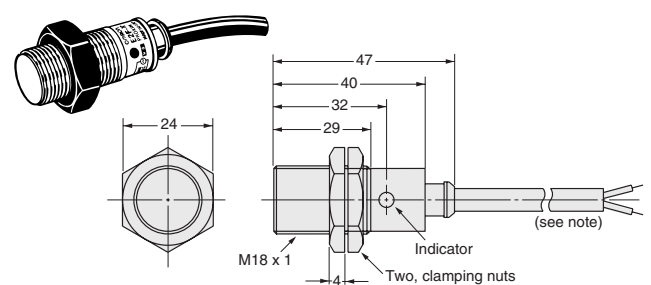

Note:  
Oil-and vibration-resistant,  
vinyl-insulated round cord, 6 dia.,  
0.5 dia. x 2 cores; Standard length: 2m  
The cord can be extended up to 200 m  
in an independent metal conduit.

**E2F-X10E**

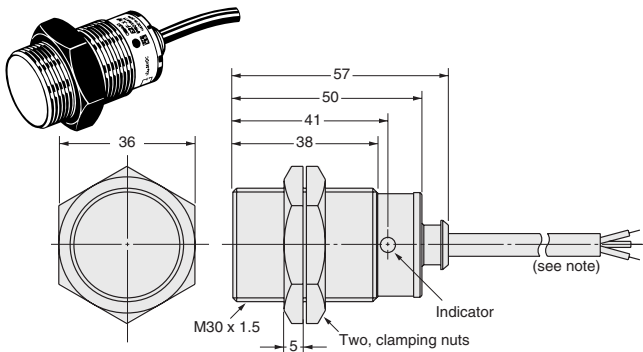

Note:  
Oil-and vibration-resistant,  
vinyl-insulated round cord, 6 dia.,  
0.5 dia. x 3 cores; Standard length: 2m  
The cord can be extended up to 200 m  
in an independent metal conduit.

**E2F-X10Y**

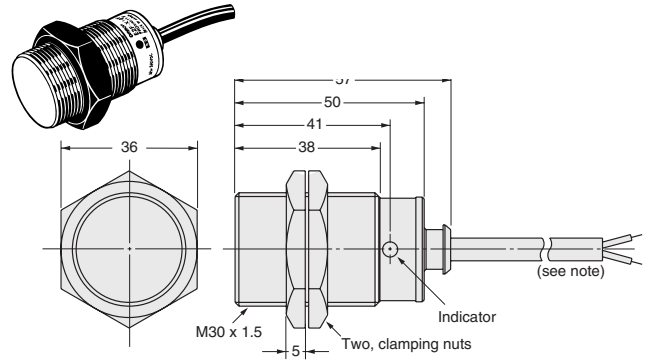

Note:  
Oil-and vibration-resistant,  
vinyl-insulated round cord, 6 dia.,  
0.5 dia. x 2 cores; Standard length: 2m  
The cord can be extended up to 200 m  
in an independent metal conduit.

**Mounting Hole Dimension**

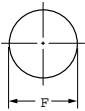

Model	E2F-X1R5	E2F-X2	E2F-X5	E2F-X10
F (mm)	8.5-mm dia. +0	12.5-mm dia. +0	18.5-mm dia. +0	30.5-mm dia. +0

ALL DIMENSIONS SHOWN ARE IN MILLIMETERS.  
To convert millimeters into inches, multiply by 0.03937. To convert grams into ounces, multiply by 0.03527.